



TEST REPORT

Test Report No. : UL-RPT-RP13337971-1616C

Customer : Raspberry Pi (Trading) Ltd
Model No. : RPI-RM0
FCC ID : 2ABCB-RPIRM0
Technology : WLAN
Test Standard(s) : FCC Part 15.407(h)(2)

1. This test report shall not be reproduced except in full, without the written approval of UL International (UK) Ltd.
2. The results in this report apply only to the sample(s) tested.
3. The sample tested is in compliance with the above standard(s).
4. The test results in this report are traceable to the national or international standards.
5. Version 1.0

Date of Issue: 20 October 2020

Checked by:

Ben Mercer
Lead Project Engineer, Radio Laboratory

Company Signatory:

Sarah Williams
Operations Leader, Radio Laboratory



5772

UL International (UK) Ltd

Unit 1-3 Horizon, Kingsland Business Park, Wade Road, Basingstoke, Hampshire, RG24 8AH, UK
Telephone: +44 (0)1256 312000
Facsimile: +44 (0)1256 312001

Customer Information

Company Name:	Raspberry Pi (Trading) Ltd
Address:	Maurice Wilkes Building Cowley Road Cambridge CB4 0DS United Kingdom

Report Revision History

Version Number	Issue Date	Revision Details	Revised By
1.0	20/10/2020	Initial Version	Ben Mercer

Table of Contents

Customer Information.....	2
Report Revision History	2
Table of Contents.....	3
1. Attestation of Test Results.....	4
1.1. Description of EUT	4
1.2. General Information	4
1.3. Summary of Test Results	4
1.4. Deviations from the Test Specification	4
2. Summary of Testing.....	5
2.1. Facilities and Accreditation	5
2.2. Methods and Procedures	5
2.3. Calibration and Uncertainty	5
2.4. Test and Measurement Equipment	6
3. Equipment Under Test (EUT)	7
3.1. Identification of Equipment Under Test (EUT)	7
3.2. Modifications Incorporated in the EUT	7
3.3. Additional Information Related to Testing	7
3.4. Description of Available Antennas	7
3.5. Description of Test Setup	8
4. Test Results	11
4.1. Channel Closing Transmission Time and Channel Move Time	11
4.2. Non-occupancy Period	14
Appendix 1. Radar Type 0 Calibration.....	16
Appendix 2. System Noise Floor Reference Plots.....	17
Appendix 3. Channel Loading.....	18

1. Attestation of Test Results





1.1. Description of EUT

The equipment under test was a *Bluetooth* and WiFi radio module.

1.2. General Information

Specification Reference:	47CFR15.407
Specification Title:	Code of Federal Regulations Volume 47 (Telecommunications): Part 15 Subpart E (Unlicensed National Information Infrastructure Devices) - Section 15.407
Test Date:	01 July 2020

1.3. Summary of Test Results

FCC Reference (47CFR)	Measurement	Note	Result
Part 15.407(h)(2)(iii)	Channel Closing Transmission Time and Channel Move Time	-	
Part 15.407(h)(2)(iv)	Non-Occupancy Period	2	
Key to Results			
 = Complied  = Did not comply			

Note(s):

- The manufacturer confirms that the information regarding the parameters of the radar waveforms is not available to the end user.
- This test is not required for a client without radar detection according to Tables 1 and 2 of KDB 905462 D02, however it was performed to show compliance with KDB 905462 D02 5.1.2 e) and KDB 905462 D03, section (b)(5) and (b)(6).

1.4. Deviations from the Test Specification

For the measurements contained within this test report, there were no deviations from, additions to, or exclusions from the test specification identified above.

2. Summary of Testing

2.1. Facilities and Accreditation

The test site and measurement facilities used to collect data are located at Unit 3 Horizon, Wade Road, Kingsland Business Park, Basingstoke, Hampshire, RG24 8AH, United Kingdom.

UL International (UK) LTD is accredited by UKAS. The tests reported herein have been performed in accordance with its terms of accreditation.

2.2. Methods and Procedures

Reference:	FCC KDB 905462 D02 UNII DFS Compliance Procedures New Rules v02 (April 08, 2016)
Title:	Compliance Measurement Procedures for Unlicensed-National Information Infrastructure Devices Operating in the 5250-5350 MHz and 5470-5725 MHz Bands Incorporating Dynamic Frequency Selection

2.3. Calibration and Uncertainty

Measuring Instrument Calibration

In accordance with UKAS requirements all the measurement equipment is on a calibration schedule. All equipment was within the calibration period on the date of testing.

Measurement Uncertainty

No measurement or test can ever be perfect and the imperfections give rise to error of measurement in the results. Consequently the result of a measurement is only an approximation to the value measured (the specific quantity subject to measurement) and is only complete when accompanied by a statement of the uncertainty of the approximation.

The expression of uncertainty of a measurement result allows realistic comparison of results with reference values and limits given in specifications and standards.

The uncertainty of the result may need to be taken into account when interpreting the measurement results.

The reported expanded uncertainties below are based on a standard uncertainty multiplied by an appropriate coverage factor such that a confidence level of approximately 95% is maintained. For the purposes of this document "approximately" is interpreted as meaning "effectively" or "for most practical purposes".

Measurement Type	Confidence Level (%)	Calculated Uncertainty
DFS Channel Shutdown Timing	95%	±0.45 ms
DFS Non-Occupancy Timing	95%	±79.25 ms
DFS Radar Amplitude	95%	±1.49 dB

The methods used to calculate the above uncertainties are in line with those recommended within the various measurement specifications. Where measurement specifications do not include guidelines for the evaluation of measurement uncertainty the published guidance of the appropriate accreditation body is followed.

2.4. Test and Measurement Equipment**Test Equipment Used:**

Asset No.	Instrument	Manufacturer	Type No.	Serial No.	Date Calibration Due	Cal. Interval (Months)
M2001	Thermohygrometer	Testo	608-H1	45041824	05 Jan 2021	12
M1835	Signal Analyser	Rohde & Schwarz	FSV30	103050	14 Apr 2021	12
G0615	Vector Signal Generator	Rohde & Schwarz	SMBV100A	260473	19 Mar 2023	36
A090	Step Attenuator	Narda	743-60	01057	Calibrated before use	-
A1536	Step Attenuator	Hewlett Packard	8494B & 8496B	30801/19649	Calibrated before use	-
A465	Step Attenuator	Hewlett Packard	8496B	3131P324	Calibrated before use	-
A1065	Step Attenuator	Hewlett Packard	8496B	3308A38165	Calibrated before use	-
A2121	Coaxial Splitter	Mini-Circuits	ZN2PD-63-S+	S UU 12701203	Calibrated before use	-
A2911	Coaxial Splitter	Mini-Circuits	ZN2PD-63-S+	S UU 50001612#3	Calibrated before use	-

3. Equipment Under Test (EUT)

3.1. Identification of Equipment Under Test (EUT)

Brand Name:	Raspberry Pi
Model Name or Number:	RPI-RM0
Test Sample Serial Number:	3103753 (<i>Conducted Sample</i>)
Hardware Version:	V1.0
Software Version:	V1.0
FCC ID:	2ABCB-RPIRM0

3.2. Modifications Incorporated in the EUT

No modifications were applied to the EUT during testing.

3.3. Additional Information Related to Testing

Technology Tested:	WLAN (IEEE 802.11a,n,ac) / U-NII	
Type of Unit:	Transceiver	
Modulation Types:	BPSK, QPSK, 16QAM, 64QAM & 256QAM	
Transmit / Receive Frequency Range:	5150 to 5350 MHz 5470 to 5850 MHz	
Transmit / Receive Channels Tested at 80 MHz Bandwidth setting:	Channel ID	Channel Centre Frequency (MHz)
	106 (Control Channel 100)	5530

3.4. Description of Available Antennas

The table below lists the internal niche antenna and the external antenna available.

Manufacturer	Type	Frequency Range (MHz)	Antenna Gain (dBi)
ProAnt	Internal	5150 to 5850	2.5
Raspberry Pi	External	5150 to 5850	2.0

3.5. Description of Test Setup

Support Equipment

The following support equipment was used to exercise the EUT during testing:

Description:	Wireless Dual Band Router (DFS Master)
Brand Name:	Cisco
Model Name or Number:	AIR-CAP3702E-A-K9 V04
FCC ID:	LDK102087
Serial Number:	FJC1938F3G6

Description:	Test Laptop
Brand Name:	Dell
Model Name or Number:	Lattitude E5400
Serial Number:	JX19G4J

Operating Modes

The EUT was tested in the following operating modes, unless otherwise stated:

- Operating on the channel selected by the Master device in either band U-NII-2A or U-NII-2C.
- The Master device controls the channel bandwidth of the EUT. Both the Master and Client device were set to 802.11ac / MCS0x1 with 80 MHz channel bandwidth to ensure a stable channel loading.
- KDB 905462 D02 v02 *UNII DFS Compliance Procedures* states in Table 2 the EUT should be tested at maximum channel bandwidth (80 MHz for 802.11ac mode).
- For the required channel loading of >17% in KDB 905642 D02 7.7 c), a UDP data transfer of 4 Mbps was performed between a test computer connected to the Master device and the EUT. This gave a channel loading (duty cycle) of 18% at the modulation scheme and bandwidth above.

Configuration and Peripherals

The EUT was tested in the following configuration(s):

- The EUT is a DFS Client without Radar Detection capability. It was tested in combination with an FCC approved Cisco DFS enabled router (FCC ID: LDK102087) acting as the Master. A Radar Type 0 was injected to the Master to test the Clients Channel Move Time and Channel Closing Transmission Time after receiving the channel shutdown command from the Master.
- All measurements were made using a conducted link. The EUT has an external antenna connector fitted for test purposes. System losses for the interconnecting hardware were measured and taken into consideration.
- The DFS detection threshold of -61.0 dBm (-62 + 1 dB) was used at the Master device antenna port. Note this is not dependent on the EUT EIRP, Spectral Density or EUT Antenna Gain, only the antenna gain of the master device, as the EUT does not have radar detection. The Cisco DFS Master device was configured with an internal setting for a 0 dBi antenna.

KDB 905462 D02 Table 3: DFS Detection Thresholds for Master Devices and Client Devices With Radar Detection

Maximum Transmit Power	Value (see notes)
EIRP ≥ 200 milliwatt	-64 dBm
EIRP < 200 milliwatt and power spectral density < 10 dBm/MHz	-62 dBm
EIRP < 200 milliwatt that do not meet the power spectral density requirement	-64 dBm
<p>Note 1: This is the level at the input of the receiver assuming a 0 dBi receive antenna</p> <p>Note 2: Throughout these test procedures an additional 1dB has been added to the amplitude of the test transmission waveforms to account for variations in measurement equipment. This will ensure that the test signal is at or above the detection threshold level to trigger a DFS response.</p> <p>Note 3: EIRP is based on the highest antenna gain. For MIMO devices refer to KDB Publication 662911 D01.</p>	

- The Master device used for test was set to 17 dBm / 50 mW with TPC enabled.
- Plots and data were captured using a Rohde and Schwarz FSV 30 Spectrum Analyser. The number of data points was increased to maximum and the trace data exported so it could be analysed in greater detail than available on the built-in display.
- The Channel Move Time was the time taken from the end of the radar waveform to the time the Client ceased transmissions. The Channel Closing Transmission Time was calculated to the nearest sample from any additional pulses occurring >200 ms after the end of the radar.

Test Setup Diagrams

Setup diagram for test of DFS Client without Radar Detection: Setup

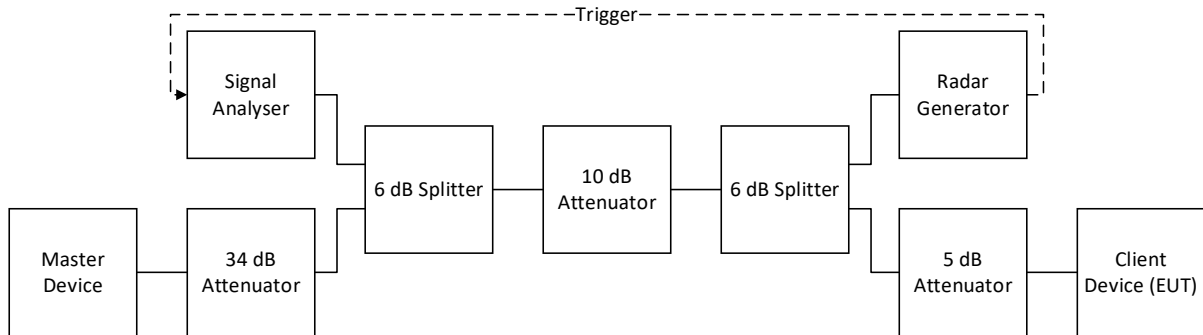

4. Test Results

4.1. Channel Closing Transmission Time and Channel Move Time

Test Summary:

Test Engineer:	Matthew Botfield	Test Date:	01 July 2020
Test Sample Serial Number:	3103753		

FCC Reference:	Part 15.407(h)(2)(iii)
Test Method Used:	KDB 905462 D02 Section 7.8.3

Environmental Conditions:

Temperature (°C):	23
Relative Humidity (%):	47

Note(s):

1. In accordance with KDB 905462 D02 Table 2, the Channel Closing Transmission Time and Channel Move Time test was performed on the widest channel bandwidth. It was therefore tested only on an 80 MHz channel bandwidth.
2. The channel move time is the time taken from the end of the radar burst to the ceasing of transmissions of the EUT.
3. The Total Aggregate Channel Closing Transmission Time shown in the table below was measured from 200 ms after the end of the radar burst and compared to the 60 ms limit.
4. Although the EUT and DFS master device 80 MHz operating channel was centred on 5530 MHz, the spectrum analyser was tuned to zero span on the control channel at 5500 MHz. The radar was also fired at 5500 MHz. This allowed any control signals to be monitored in addition to the 80 MHz data transfer.
5. The transmissions seen in the plot below 0 dBm originate from the Master device. These transmissions can be ignored for the below results.

Channel Closing Transmission Time and Channel Move Time (continued)

Results: Channel Move Time

Channel (MHz)	Move Time (ms)	Limit (ms)	Margin (ms)	Result
5530	30.9	10000	9969.1	Complied

Results: Channel Closing Transmission Time

Channel (MHz)	Total Aggregate Tx Time Occurring After time [t ₁ +200 ms] (ms)	Limit (ms)	Margin (ms)	Result
5530	0.0	60.0	60.0	Complied

Results: 80 MHz EUT to Master

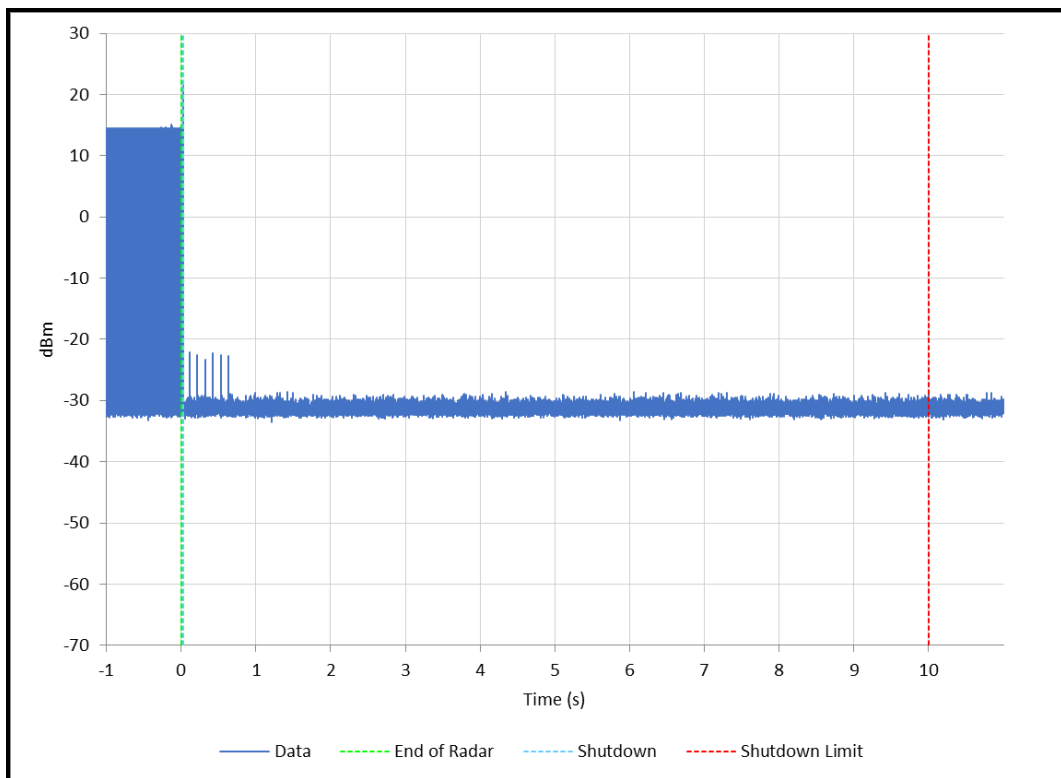

Plot showing the full 10 second shutdown limit

Channel Closing Transmission Time and Channel Move Time (continued)**Limits:****Part 15.407(h)(2)(iii)**

After a radar's presence is detected, all transmissions shall cease on the operating channel within 10 seconds. Transmissions during this period shall consist of normal traffic for a maximum of 200 ms after detection of the radar signal. In addition, intermittent management and control signals can be sent during the remaining time to facilitate vacating the operating channel.

KDB 905462 D02 Table 4: DFS Response Requirement Values

Parameter	Value
<i>Channel Move Time</i>	10 seconds See Note 1.
<i>Channel Closing Transmission Time</i>	200 milliseconds + an aggregate of 60 milliseconds over remaining 10 second period. See Notes 1 and 2.
<p>Note 1: <i>Channel Move Time</i> and the <i>Channel Closing Transmission Time</i> should be performed with Radar Type 0. The measurement timing begins at the end of the Radar Type 0 burst.</p> <p>Note 2: The <i>Channel Closing Transmission Time</i> is comprised of 200 milliseconds starting at the beginning of the <i>Channel Move Time</i> plus any additional intermittent control signals required to facilitate a <i>Channel</i> move (an aggregate of 60 milliseconds) during the remainder of the 10 second period. The aggregate duration of control signals will not count quiet periods in between transmissions.</p>	

4.2. Non-occupancy Period

Test Summary:

Test Engineer:	Matthew Botfield	Test Date:	01 July 2020
Test Sample Serial Number:	3103753		

FCC Reference:	Part 15.407(h)(2)(iv)
Test Method Used:	KDB 905462 D02 Section 7.8.3

Environmental Conditions:

Temperature (°C):	23
Relative Humidity (%):	47

Notes:

1. This test is not required for a client without radar detection according to Tables 1 and 2 of KDB 905462 D02, however it was performed to show compliance with KDB 905462 D02 5.1.2 e) and KDB 905462 D03, section (b)(5) and (b)(6). Therefore no specified bandwidth requirement is given and so was performed using an 80 MHz channel bandwidth; as used for *Channel Closing Transmission Time and Channel Move Time*.
2. Radar burst type 0 was detected and the channel was vacated for >1800 seconds. Since the EUT has no radar detection and is therefore not performing an 'intelligent' blacklisting of the channel, the device was shown not to transmit for greater than 30 minutes after its own shutdown time, not the shutdown of the DFS Master.
3. Although the EUT and DFS master device 80 MHz operating channel was centred on 5290 MHz, the spectrum analyser was tuned to zero span at 5260 MHz. The radar was also fired at 5260 MHz. This allowed any control signals to be monitored in addition to the 80 MHz data transfer
4. The noise floor remained below the -21.2 dBm/MHz (74 dBµV/m at 3m) unintentional radiator limit for the 30 minute (1800 seconds) non-occupancy period. Therefore the EUT is deemed to comply.

Non-occupancy Period (continued)

Results:

Channel (MHz)	Non-occupancy (min)	Limit (min)	Margin (min)	Result
5530	>34.5	30.0	>4.5	Complied

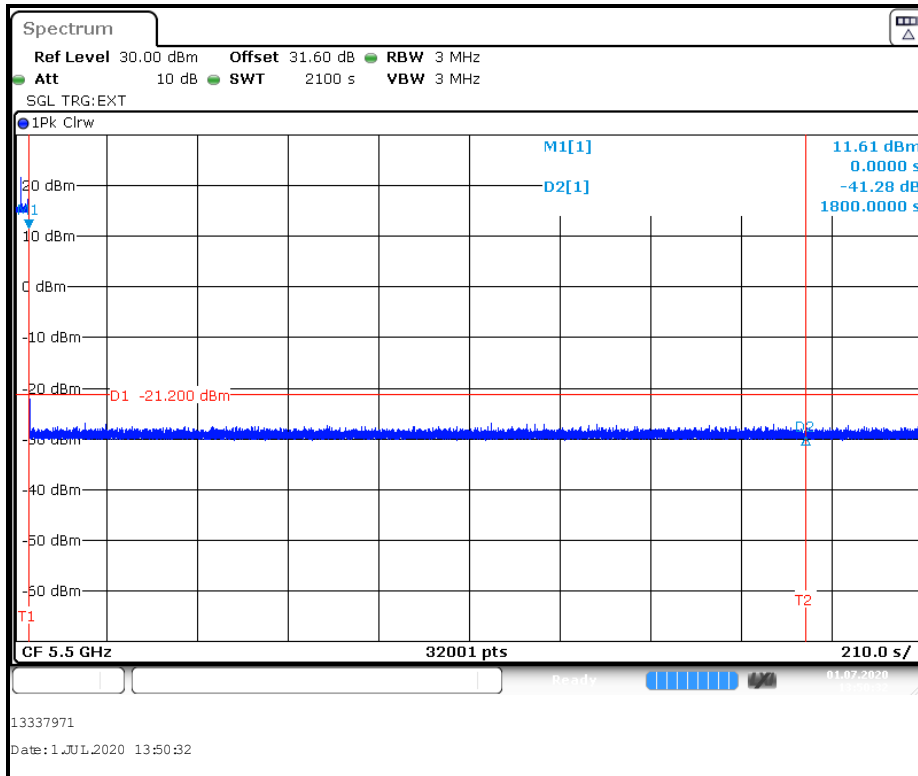

Limits:

Part 15.407(h)(2)(iv)

A channel that has been flagged as containing a radar system, either by a channel availability check or in-service monitoring, is subject to a non-occupancy period of at least 30 minutes. The non-occupancy period starts at the time when the radar system is detected.

KDB 905462 D02 Table 4: DFS Response Requirement Values

Parameter	Value
Non-occupancy period	Minimum 30 minutes

Appendix 1. Radar Type 0 Calibration

Radar calibration procedure.

The system was configured as shown in section 3.5, but with the path from the EUT to the signal analyser terminated into a 50Ω load, and the path from the radar generator to the master connected to the signal analyser. The radar was then replayed by the SMBV100A vector signal generator, the waveform captured, and the amplitude adjusted until correct.

Below is an example plot of the type 0 radar burst at the master port of the attenuation network. The vector signal generator was set to -4.4 dBm output to give the -61.0 dBm level.

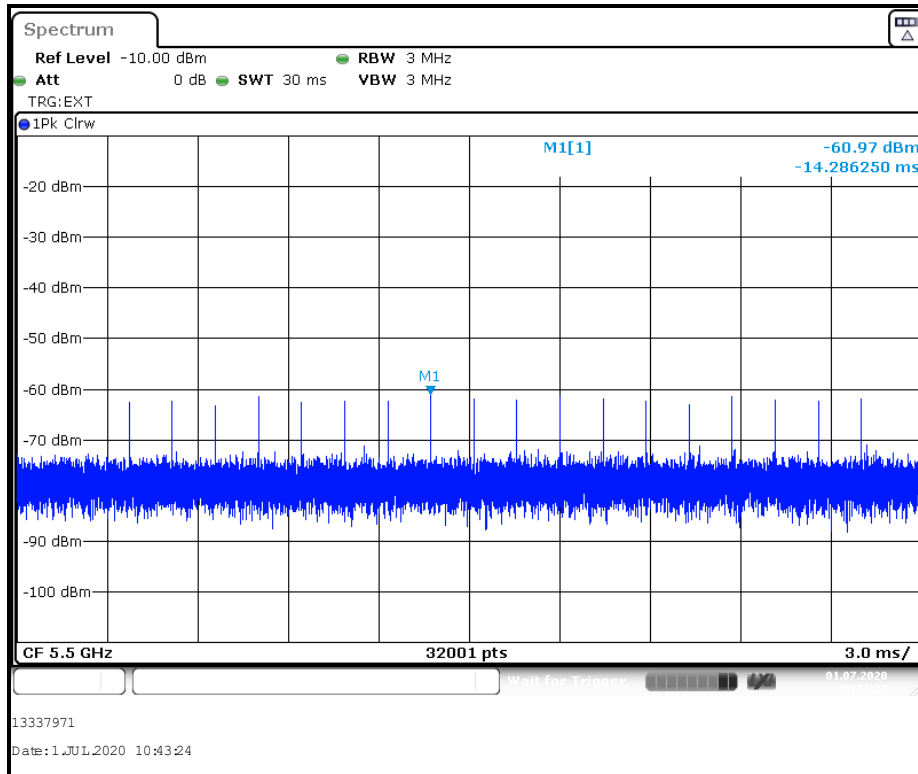

Radar Type 0 – full 18 pulse waveform

Appendix 2. System Noise Floor Reference Plots

As required by Section 8.3 d)3) and 8.3 g) of KDB 905462 D02, the following plot shows the reference noise floor of the system used during measurement. It also shows compliance with Section 8.3.7 of KDB 905462 D02 when the path loss of the coupling network shows in Section 3.5 Configuration and peripherals is added to the noise floor.

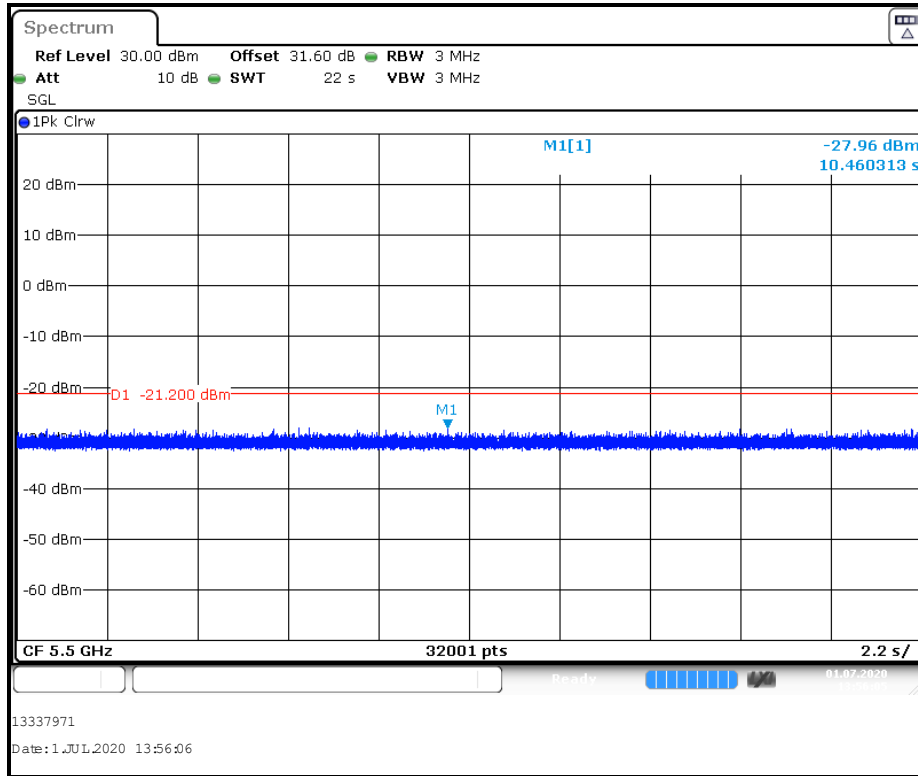

Noise Floor of Spectrum Analyser

Appendix 3. Channel Loading

As required by Section 8.3. c) 6) of KDB 905462 D02, the following plot and calculations shows the duty cycle of the channel used during testing.

When using an 80 MHz channel bandwidth, streaming representative file types as defined in Section 7.7 a) of KDB 905462 D02, were found not to produce a high enough duty cycle of >17%, as required by 7.7 c), and gave very irregular loading due to large video buffers. Therefore an alternative UDP pseudo-random data transfer as per 7.7 b) was streamed to simulate data transfer.

The duty cycle was calculated over 100 milliseconds. This was captured on a spectrum analyser in the time domain using a 0 Hz span and 32000 sweep points to ensure it included any longer term variations, whilst maintaining accurate to a 3.125 µs sample size.

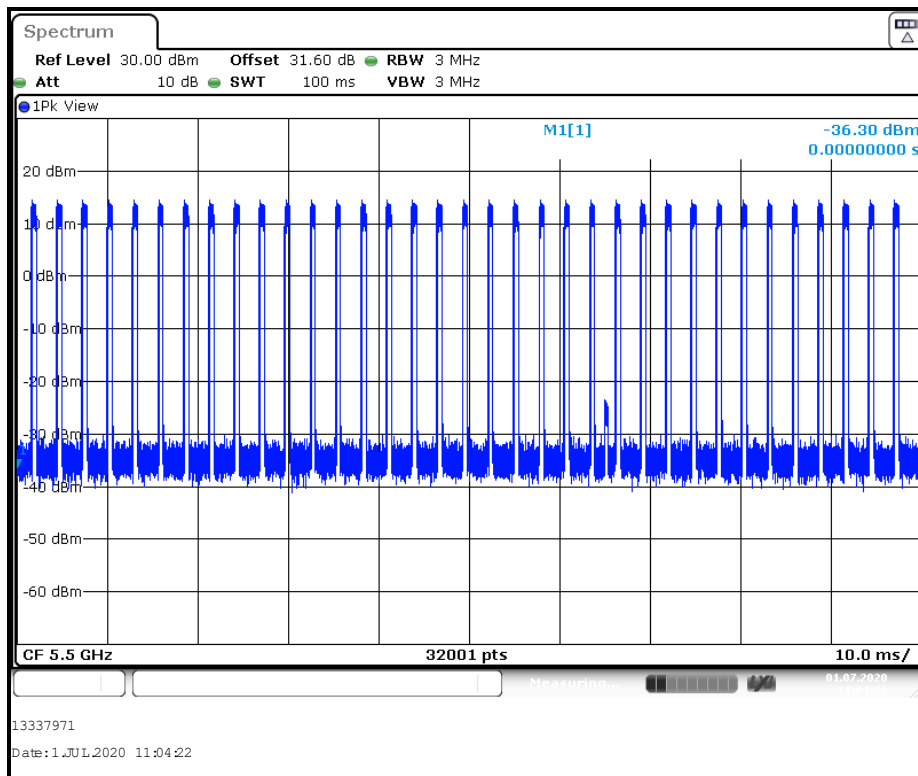

The number of samples greater than -10 dBm was compared to the total number of samples to calculate the duty cycle. The EUT was found to be transmitting above the requirement of greater than 17 % channel loading.

--- END OF REPORT ---